



HYDROFIRE ΕΠΕ

Buildings - Industry - Marine – Waterworks
END OF AG. PANTELEIMONOS Str. (ELEONAS)
GR-12241 EGALEO,
Tel.: +30 210 3412 749-750 Fax: +30 210 3412 406
www.hydrofire.gr, email: info@hydrofire.gr



FireLock® Butterfly Valve Series 705 with Weatherproof Actuator



10.81



1.0 PRODUCT DESCRIPTION

- Available Sizes: 2 – 12”/50 – 300 mm
- cULus Listed, LPCB Listed, FM and VdS Approved for service up to 300 psi/2068 kPa /20 bar.
- Designed for fire protection services only.
- Features a weatherproof actuator housing Approved for indoor and outdoor use.
- Actuation options: Hand wheel (2 – 12”/50 – 300 mm)
- Exclusively for use with pipe and Victaulic products which feature ends formed with the Victaulic Original Groove System (OGS) groove profile (see section 7.0 for Reference Materials).

2.0 CERTIFICATION/LISTINGS



G410001



LPS 1195: Issue 3.1
Cert/LPCB Ref. 104J/01
8462/01



ALWAYS REFER TO ANY NOTIFICATIONS AT THE END OF THIS DOCUMENT REGARDING PRODUCT INSTALLATION, MAINTENANCE OR SUPPORT.

System No.		Location	
Submitted By		Date	

Spec Section		Paragraph	
Approved		Date	

victaulic.com

10.81 05662 Rev J Updated 03/2021 © 2021 Victaulic Company. All rights reserved.





HYDROFIRE ΕΠΕ

Buildings - Industry - Marine – Waterworks
 END OF AG. PANTELEIMONOS Str. (ELEONAS)
 GR-12241 EGALEO,
 Tel.: +30 210 3412 749-750 Fax: +30 210 3412 406
www.hydrofire.gr, email: info@hydrofire.gr



victaulic.com

2.1 CERTIFICATION/LISTINGS

Size	Approval/Listing Service Pressures			
	Series 705 Butterfly Valve			
	cULus	FM	Vds	LPCB
2 50	up to 300psi/2068kPa	up to 300psi/2068kPa	up to 300psi/2068kPa	up to 300psi/2068kPa
2½ 65	up to 300psi/2068kPa	up to 300psi/2068kPa	n/a	up to 300psi/2068kPa
76.1 mm	up to 300psi/2068kPa	up to 300psi/2068kPa	up to 300psi/2068kPa	up to 300psi/2068kPa
3 80	up to 300psi/2068kPa	up to 300psi/2068kPa	up to 300psi/2068kPa	up to 300psi/2068kPa
4 100	up to 300psi/2068kPa	up to 300psi/2068kPa	up to 300psi/2068kPa	up to 300psi/2068kPa
5 125	up to 300psi/2068kPa	up to 300psi/2068kPa	n/a	up to 300psi/2068kPa
139.7 mm	up to 300psi/2068kPa	up to 300psi/2068kPa	up to 300psi/2068kPa	up to 300psi/2068kPa
6 150	up to 300psi/2068kPa	up to 300psi/2068kPa	up to 300psi/2068kPa	up to 300psi/2068kPa
165.1 mm	up to 300psi/2068kPa	up to 300psi/2068kPa	n/a	up to 300psi/2068kPa
8 200	up to 300psi/2068kPa	up to 300psi/2068kPa	up to 300psi/2068kPa	up to 300psi/2068kPa
10 250	up to 300psi/2068kPa	up to 300psi/2068kPa	n/a	up to 300psi/2068kPa
12 300	up to 300psi/2068kPa	up to 300psi/2068kPa	n/a	up to 300psi/2068kPa

3.0 SPECIFICATIONS – MATERIAL

Body: Ductile Iron conforming to ASTM A-536, Grade 65-45-12

End Face, 2 – 6”/50 – 150 mm: Ductile Iron conforming to ASTM A-536, Grade 65-45-12

Seal Retainer, 8 – 12”/200 – 300 mm: Ductile Iron conforming to ASTM A-536, Grade 65-45-12

Body Coating: Black alkyd enamel

Disc: Ductile Iron conforming to ASTM A-536, Grade 65-45-12, with electroless nickel coating conforming to ASTM B-733

Seat: Grade “E” EPDM

Stems: 416 stainless steel conforming to ASTM A-582

Stem Seal Cartridge: C36000 brass

Bearings: Stainless steel with TFE lining

Stem Seals: EPDM

Stem Retaining Ring: Carbon steel

Actuator:

- 2 – 8”/50 – 200 mm: Brass or bronze traveling nut on a steel lead screw, in a ductile iron housing
- 10 – 12”/250 – 300 mm: Steel worm and cast iron quadrant gear, in a cast iron housing



HYDROFIRE ΕΠΕ

Buildings - Industry - Marine – Waterworks
 END OF AG. PANTELEIMONOS Str. (ELEONAS)
 GR-12241 EGALEO,

Tel.: +30 210 3412 749-750 Fax: +30 210 3412 406
www.hydrofire.gr, email: info@hydrofire.gr



victaulic.com

4.0 DIMENSIONS

Series 705

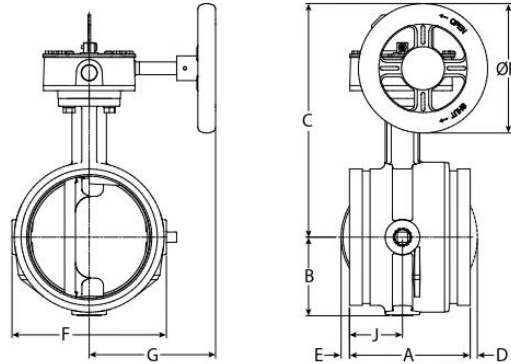

Size		Dimensions								
Nominal inches mm	Actual Outside Diameter mm	E to E A inches mm	B inches mm	C inches mm	D inches mm	E inches mm	F inches mm	G inches mm	DIA H inches mm	J inches mm
2 60.3	2.375 60.3	4.25 108.0	2.28 57.9	6.41 162.8	-	-	4.00 101.6	4.22 107.2	4.50 114.3	2.12 53.8
2½ 73	2.875 73.0	3.77 95.8	2.28 57.9	7.54 191.5	-	-	4.00 101.6	4.22 107.2	4.50 114.3	1.77 45.0
76.1mm	3.000 76.1	3.77 95.8	2.28 57.9	7.54 191.5	-	-	4.00 101.6	4.22 107.2	4.50 114.3	1.77 45.0
3 88.9	3.500 88.9	3.77 95.8	2.53 64.3	7.79 197.9	-	-	4.50 114.3	4.22 107.2	4.50 114.3	1.77 45.0
108mm	4.250 108.0	4.63 117.6	2.88 73.2	8.81 223.8	-	-	5.50 139.7	4.22 107.2	4.50 114.3	2.20 55.9
4 114.3	4.500 114.3	4.63 117.6	2.88 73.2	8.81 223.8	-	-	5.50 139.7	4.22 107.2	4.50 114.3	2.20 55.9
133mm	5.250 133.0	5.88 149.4	3.35 85.1	10.88 276.4	-	-	6.56 166.6	6.19 157.2	6.30 160.0	2.58 65.5
139.7mm	5.500 139.7	5.88 149.4	3.35 85.1	10.88 276.4	-	-	6.56 166.6	6.19 157.2	6.30 160.0	2.58 65.6
5 141.3	5.563 141.3	5.88 149.4	3.35 85.1	10.88 276.4	-	-	6.56 166.6	6.19 157.2	6.30 160.0	2.58 65.5
159mm	6.250 159.0	5.88 149.4	3.84 97.5	11.38 289.1	-	0.41 10.4	7.52 191.0	6.19 157.2	6.30 160.0	2.58 65.5
165.1mm	6.500 165.1	5.88 149.4	3.84 97.5	11.38 289.1	-	0.41 10.4	7.52 191.0	6.19 157.2	6.30 160.0	2.58 65.5
6 168.3	6.625 168.3	5.88 149.4	3.84 97.5	11.38 289.1	-	0.41 10.4	7.52 191.0	6.19 157.2	6.30 160.0	1.90 48.3
8 219.1	8.625 219.1	5.33 135.4	5.07 128.8	13.53 343.6	0.80 20.3	1.47 37.3	10.00 254.0	6.19 157.2	8.10 205.7	2.33 59.2
10 273	10.750 273.0	6.40 162.6	6.37 161.8	15.64 397.3	1.41 35.8	1.81 46.0	12.25 311.2	8.10 205.7	9.00 228.6	-
12 323.9	12.750 323.9	6.50 165.1	7.36 186.9	16.64 422.7	2.30 58.4	2.80 71.1	14.25 362.0	8.10 205.7	9.00 228.6	-

NOTE

- Optional ½"/15mm tap available. Contact Victaulic for details.



HYDROFIRE ΕΠΕ

Buildings - Industry - Marine – Waterworks
END OF AG. PANTELEIMONOS Str. (ELEONAS)
GR-12241 EGALEO,

Tel.: +30 210 3412 749-750 Fax: +30 210 3412 406
www.hydrofire.gr, email: info@hydrofire.gr



victaulic.com

5.0 PERFORMANCE

Series 705

The chart expresses the frictional resistance of Victaulic Series 705 Butterfly Valve in equivalent feet/meters of straight pipe.

Nominal Size mm inches	Outside Diameter mm inches	Equivalent
		Feet/m of pipe
2 50	2.375 60.3	6 1.8
2½ 65	2.875 73.0	6 1.8
76.1 mm	3.000 76.1	6 1.8
3 80	3.500 88.9	7 2.1
4 100	4.500 114.3	8 2.4
108 mm	108 mm	8 2.4
5 125	5.563 141.3	12 3.7
133 mm	133 mm	12 3.7
139.7 mm	5.500 139.7	12 3.7
6 150	6.625 168.3	14 4.2
159 mm	159 mm	14 4.3
165.1 mm	6.500 165.1	14 4.2
8 200	8.625 219.1	16 4.9
10 250	10.750 273.0	18 5.5
12 300	12.750 323.9	19 5.8



HYDROFIRE ΕΠΕ

Buildings - Industry - Marine – Waterworks
 END OF AG. PANTELEIMONOS Str. (ELEONAS)
 GR-12241 EGALEO,

Tel.: +30 210 3412 749-750 Fax: +30 210 3412 406
www.hydrofire.gr, email: info@hydrofire.gr



victaulic.com

5.1 PERFORMANCE

Series 705

C_v values for flow of water at +60°F/+16°C through a fully open valve are shown in the table below.
 For additional details, contact Victaulic.

Formulas for C_v values

$$\Delta P = \frac{Q^2}{C_v^2}$$

$$Q = C_v \times \sqrt{\Delta P}$$

Where:

Q = Flow (GPM)

ΔP = Pressure Drop (psi)

C_v = Flow Coefficient

Formulas for K_v values

$$\Delta P = \frac{Q^2}{K_v^2}$$

$$Q = K_v \times \sqrt{\Delta P}$$

Where:

Q = Flow (m³/hr)

ΔP = Pressure Drop (Bar)

K_v = Flow Coefficient

Valve Size		Full Open
Nominal Size inches mm	Actual Outside Diameter inches mm	Flow Coefficient C_v
2 50	2.375 60.3	170
2½ 65	2.875 73.0	260
76.1 mm	3.000 76.1	260
3 80	3.500 88.9	440
4 100	4.500 114.3	820
108 mm	108 mm	820
5 125	5.563 141.3	1200
133 mm	133 mm	1200
139.7 mm	5.500 139.7	1200
6 150	6.625 168.3	1800
159 mm	159 mm	1800
165.1 mm	6.500 165.1	1800
8 200	8.625 219.1	3400
10 250	10.750 273.0	5800
12 300	12.750 323.9	9000

Valve Size		Full Open
Nominal Size inches mm	Actual Outside Diameter inches mm	Flow Coefficient K_v
2 50	2.375 60.3	147
2½ 65	2.875 73.0	225
76.1 mm	3.000 76.1	225
3 80	3.500 88.9	380
4 100	4.500 114.3	710
108 mm	108 mm	710
5 125	5.563 141.3	1040
133 mm	133 mm	1040
139.7 mm	5.500 139.7	1040
6 150	6.625 168.3	1560
159 mm	159 mm	1560
165.1 mm	6.500 165.1	1560
8 200	8.625 219.1	2940
10 250	10.750 273.0	5020
12 300	12.750 323.9	7790



HYDROFIRE ΕΠΕ

Buildings - Industry - Marine – Waterworks
END OF AG. PANTELEIMONOS Str. (ELEONAS)
GR-12241 EGALEO,







Tel.: +30 210 3412 749-750 Fax: +30 210 3412 406
www.hydrofire.gr, email: info@hydrofire.gr



victaulic.com

6.0 NOTIFICATIONS

⚠ WARNING

- Read and understand all instructions before attempting to install, remove, adjust, or maintain any Victaulic piping products.
- Depressurize and drain the piping system before attempting to install, remove, adjust, or maintain any Victaulic piping products.
- Wear safety glasses, hardhat, and foot protection.

Failure to follow these instructions could result in death or serious personal injury and property damage.

7.0 REFERENCE MATERIALS

Switch and Wiring

1. The supervisory switch contains two single pole, double throw, pre-wired switches.
2. Switches are rated:
10 amps @ 125 or 250 VAC/60 Hz
0.50 amps @ 125 VDC
0.25 amps @ 250 VDC
3. Switches supervise the valve in the “OPEN” position.
5. One switch has two #18 insulated wires per terminal, which permit complete supervision of leads (refer to diagrams and notes below). The second switch has one #18 insulated wire per terminal. This double circuit provides flexibility to operate two electrical devices at separate locations, such as an indicating light and an audible alarm, in the area that the valve is installed.
6. A #14 insulated ground lead (green) is provided.

Switch #1 = S1

For connection to the supervisory circuit of a UL Listed alarm control panel

Switch #2 = S2

Auxiliary switch that may be connected to auxiliary devices, per the authority having jurisdiction

S1 { Normally Closed: (2) Blue
Common: (2) Yellow

S2 { Normally Closed: Blue with Orange Stripe
Normally Open: Brown with Orange Stripe
Common: Yellow with Orange Stripe

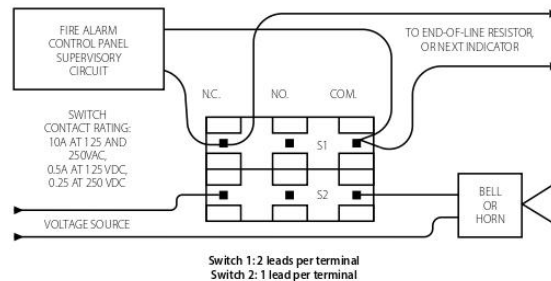
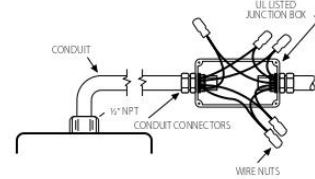

NOTES

- The above diagram shows a connection between the common terminal (yellow – S1 and yellow-with-orange stripe – S2) and the normally closed terminal (blue – S1 and blue-with-orange stripe – S2). In this example, the indicator light and alarm will stay on until the valve is fully open. When the valve is fully open, the indicator light and alarm will go out. Cap off any unused wires (e.g. brown with orange stripe).
- Only S1 (two leads per terminal) may be connected to the fire alarm control panel.
- The connection of the alarm switch wiring shall be in accordance with NFPA 72 and the auxiliary switch per NFPA 70 (NEC).