



HYDROFIRE ΕΠΕ

Buildings - Industry - Marine – Waterworks
END OF AG. PANTELEIMONOS Str. (ELEONAS)
GR-12241 EGALEO,
Tel.: +30 210 3412 749-750 Fax: +30 210 3412 406
www.hydrofire.gr, email: info@hydrofire.gr



BOCCELLO A GETTO PIENO/NEBULIZZATO ACQUA / SCHIUMA Mod. FI – BA JET / FOG WATER / FOAM NOZZLE Mod. FI - BA



CARATTERISTICHE:

- Corpo: in acciaio inox
- Attacco: Flangiato. A richiesta filettato 2 ½" gas M / F
- Resa schiuma: 1 – 7 (se usato con schiumogeni adeguati)

CHARACTERISTICS:

- Body: stainless steel
- Connection: Flanged. On Req. threaded 2 ½" gas M / F
- Expansion: 1- 7 (if used with adequate foam compound)





HYDROFIRE ΕΠΕ

Buildings - Industry - Marine – Waterworks
 END OF AG. PANTELEIMONOS Str. (ELEONAS)
 GR-12241 EGALEO,

Tel.: +30 210 3412 749-750 Fax: +30 210 3412 406
www.hydrofire.gr, email: info@hydrofire.gr



BOCCELLO A GETTO PIENO/NEBULIZZATO ACQUA / SCHIUMA Mod. FI – BA 3-15 JET / FOG WATER / FOAM NOZZLE Mod. FI - BA 3-15

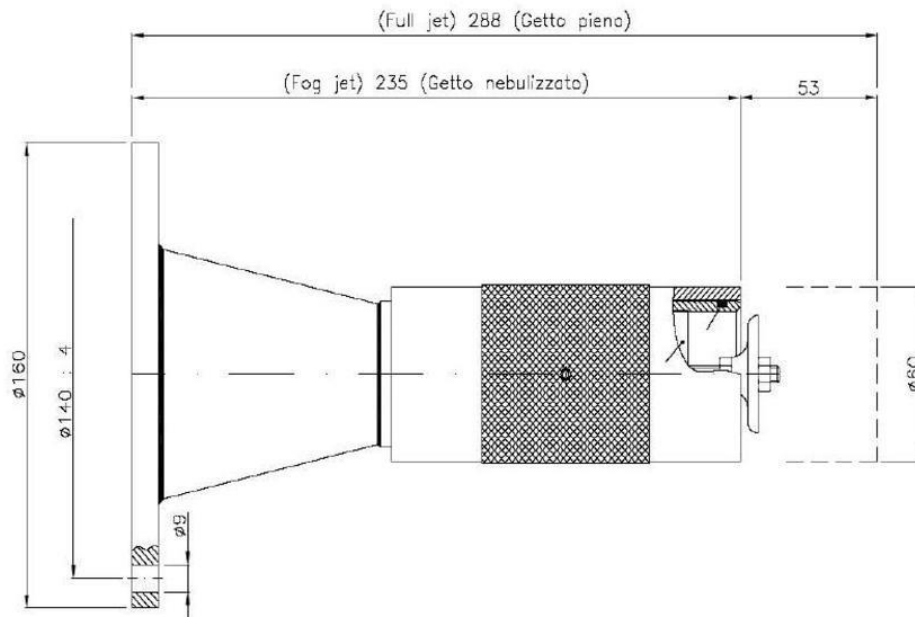

Model	PRESSURE IN BAR									
	5	6	7	8	9	10	11	12	13	14
	FLOW (Lts./1')									
FI-BA 3	292	320	346	369	392	413	433	453	471	489
FI-BA 5	455	499	539	576	611	644	675	705	734	762
FI-BA 7	659	722	780	833	884	932	977	1021	1062	1103
FI-BA 9	809	886	958	1024	1086	1145	1200	1254	1305	1354
FI-BA 11	994	1089	1177	1258	1334	1406	1475	1541	1604	1665
FI-BA 13	1173	1285	1389	1484	1574	1660	1741	1819	1893	1015
FI-BA 15	1341	1469	1587	1696	1799	1897	1989	2078	2163	2245





HYDROFIRE ΕΠΕ

Buildings - Industry - Marine – Waterworks
END OF AG. PANTELEIMONOS Str. (ELEONAS)
GR-12241 EGALEO,

Tel.: +30 210 3412 749-750 Fax: +30 210 3412 406
www.hydrofire.gr, email: info@hydrofire.gr



Throw Curves Jet Mode

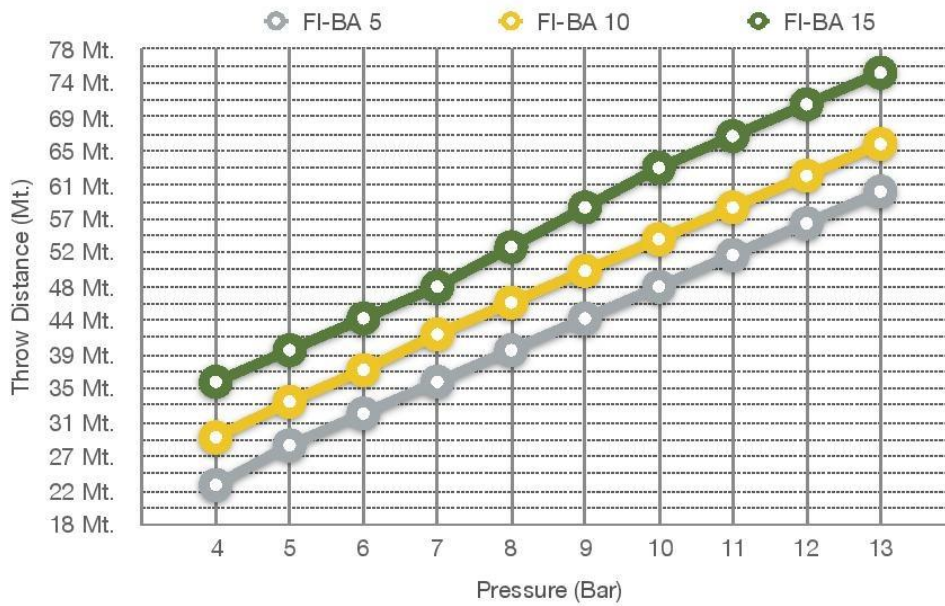

Throw Curves Fog Mode

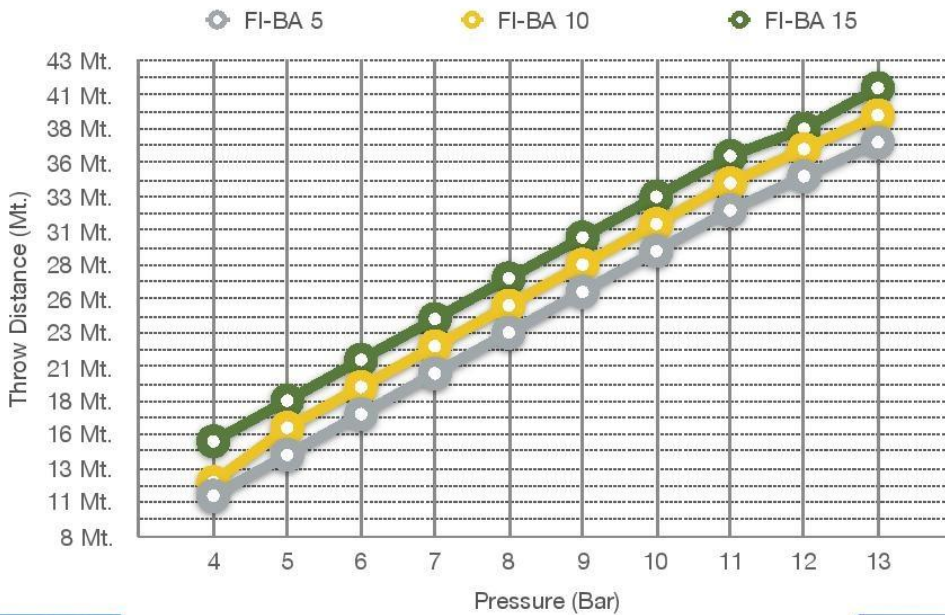



HYDROFIRE ΕΠΕ

Buildings - Industry - Marine – Waterworks
END OF AG. PANTELEIMONOS Str. (ELEONAS)
GR-12241 EGALEO,

Tel.: +30 210 3412 749-750 Fax: +30 210 3412 406

www.hydrofire.gr, email: info@hydrofire.gr



BOCCELLO A GETTO PIENO/NEBULIZZATO ACQUA / SCHIUMA Mod. FI – BA 15-25 25-85 JET / FOG WATER / FOAM NOZZLE Mod. FI - BA 15-25 25-85

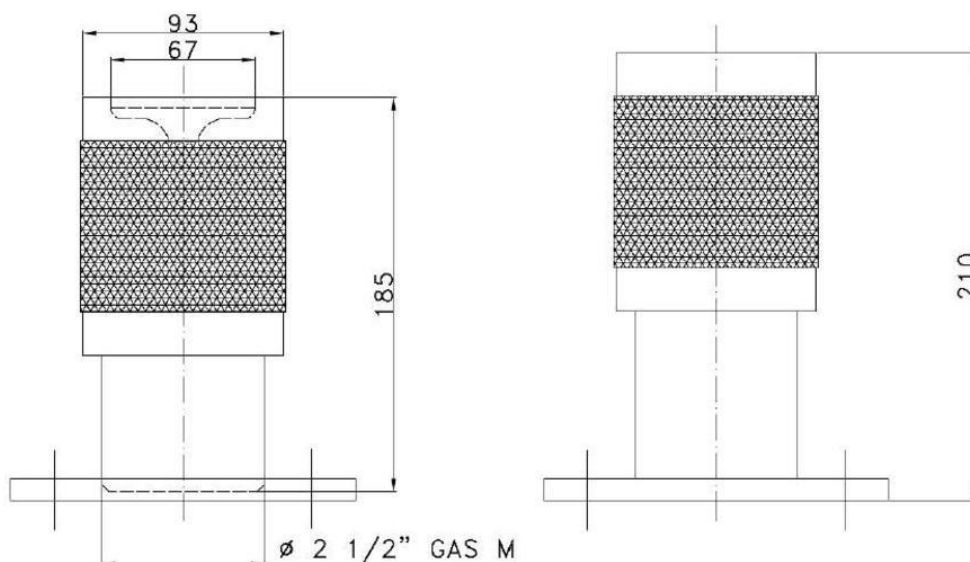

CARATTERISTICHE:

- Corpo: in acciaio inox
- Attacco: Flangiato. A richiesta filettato 2 ½" gas M / F
- Resa schiuma: 1 – 7 (se usato con schiumogeni adeguati)

CHARACTERISTICS:

- Body: stainless steel
- Connection: Flanged. On Req. threaded 2 ½" gas M / F
- Expansion: 1- 7 (if used with adequate foam compound)





HYDROFIRE ΕΠΕ

Buildings - Industry - Marine – Waterworks
END OF AG. PANTELEIMONOS Str. (ELEONAS)
GR-12241 EGALEO,

Tel.: +30 210 3412 749-750 Fax: +30 210 3412 406
www.hydrofire.gr, email: info@hydrofire.gr



MODELLO MODEL	PESO/ WEIGHT (Kg.)	PORTATA FLOW RATE	MATERIALE MATERIAL
FI-BA 15-25	5	1500 – 2500	S.STEEL
FI-BA 25-85	8	2500 - 8500	S.STEEL

Model	PRESSURE IN BAR									
	5	6	7	8	9	10	11	12	13	14
	FLOW (Lts./1')									
FI-BA 15	1270	1390	1500	1605	1700	1795	1880	1965	2045	2120
FI-BA 20	1690	1850	2000	2140	2270	2390	2510	2620	2725	2830
FI-BA 25	2115	2315	2500	2675	2835	2990	3135	3275	3410	3535
FI-BA 30	2535	2780	3000	3210	3400	3585	3760	3930	4090	4245
FI-BA 35	2960	3240	3500	3740	3970	4180	4390	4580	4770	4950
FI-BA 40	3380	3700	4000	4275	4535	4780	5015	5235	5450	5655
FI-BA 45	3800	4165	4500	4810	5100	5380	5640	5890	6130	6360
FI-BA 50	4225	4630	5000	5345	5670	5975	6265	6545	6815	7070
FI-BA 55	4649	5092	5500	5908	6237	6574	6895	7202	7496	7779
FI-BA 60	5071	5555	6000	6415	6804	7172	7522	7857	8177	8486
FI-BA 65	5494	6018	6500	6949	7371	7770	8149	8511	8859	9193
FI-BA 70	5939	6481	7000	7484	7938	8367	8776	9166	9540	9900
FI-BA 75	6339	6944	7500	8019	8505	8965	9403	9821	10222	10608
FI-BA 80	6762	7407	8000	8553	9072	9563	10029	10475	10903	11315
FI-BA 85	7184	7870	8500	9088	9639	10160	10656	11130	11585	12022





HYDROFIRE ΕΠΕ

Buildings - Industry - Marine – Waterworks
END OF AG. PANTELEIMONOS Str. (ELEONAS)
GR-12241 EGALEO,

Tel.: +30 210 3412 749-750 Fax: +30 210 3412 406
www.hydrofire.gr, email: info@hydrofire.gr



Throw Curves Jet Mode

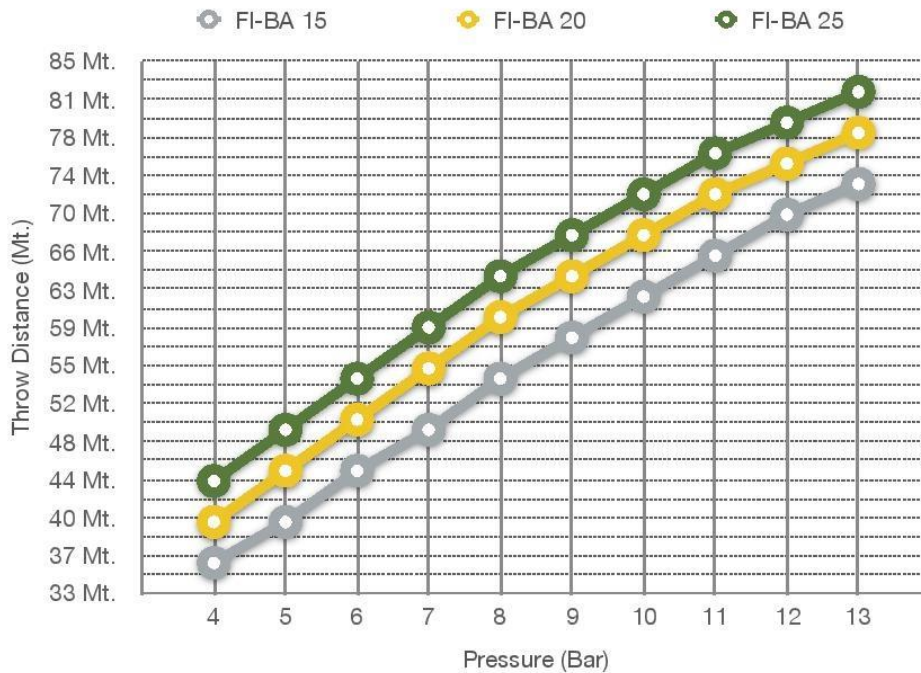

Throw Curves Fog Mode

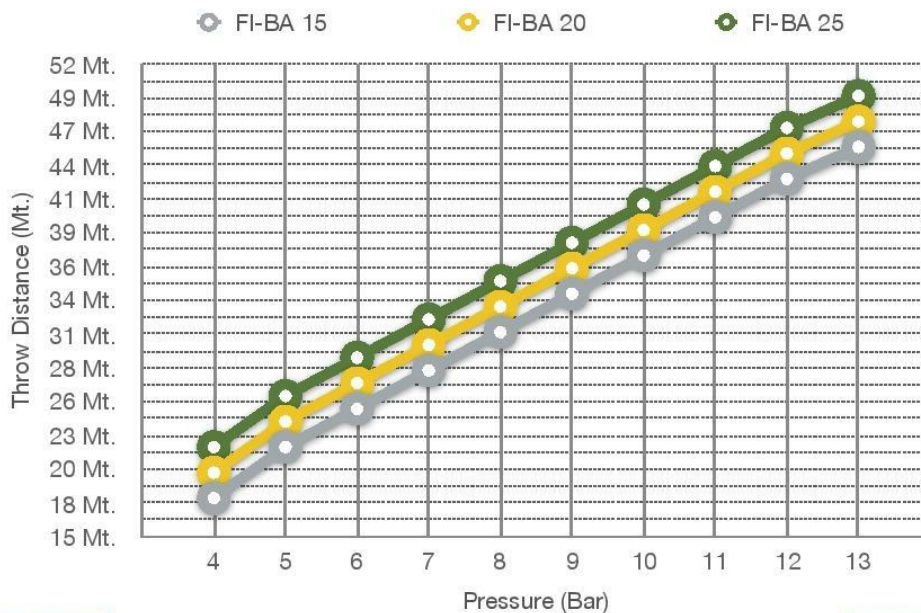



HYDROFIRE ΕΠΕ

Buildings - Industry - Marine – Waterworks
END OF AG. PANTELEIMONOS Str. (ELEONAS)
GR-12241 EGALEO,

Tel.: +30 210 3412 749-750 Fax: +30 210 3412 406
www.hydrofire.gr, email: info@hydrofire.gr



Throw Curves Jet Mode

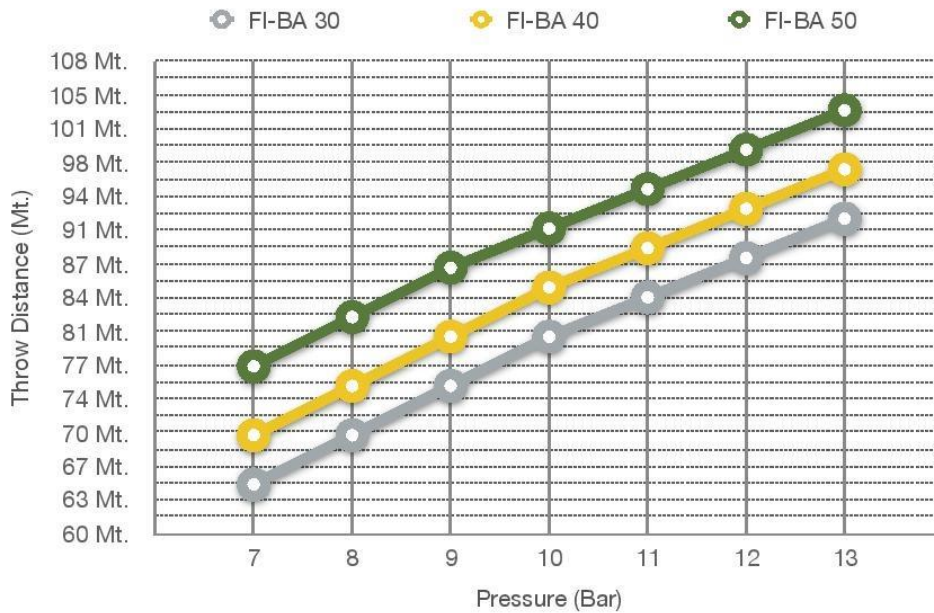

Throw Curves Fog Mode

